

UCC28600 120-W Evaluation Module

User's Guide

UCC28600 120-W Evaluation Module

User's Guide

Literature Number: SLUU256A
August 2006—Revised October 2006

UCC28600 120-W Evaluation Module

The UCC28600 evaluation module (EVM) is a 120-W off-line quasi-resonant flyback converter providing a 19.4-V regulated output at 6.2 A of load current, operating from a universal ac input. The front-end power factor correction (PFC) stage is controlled by the UCC28051 and accommodates an input line voltage range of 85 VRMS to 265 VRMS and is designed to meet EIC61000-3-2 harmonic emissions requirements. The module uses the UCC28600 Quasi-Resonant Flyback Green-Mode Controller which integrates built-in state of the art energy saving features with high level protection features to provide cost effective solutions for energy efficient power supplies.

1 Description

The UCC28600EVM highlights the many benefits of using the UCC28600 Quasi-Resonant Flyback Green-Mode Controller. Low system parts count and multifunction pins in this green-mode controller provide a cost-effective solution while meeting stringent world-wide energy efficiency requirements. Low voltage switching reduces switching losses and improves efficiency. Green-mode and frequency-foldback mode operation reduces the operating frequency at light loads and no-load operation. A dedicated STATUS pin is used to disable the PFC controller when the converter has entered standby.

This user's guide provides the schematic, component list, assembly drawing for a single-sided PCB application, artwork, and test set up necessary to evaluate the UCC28600 in a typical off-line converter application.

1.1 Applications

The UCC28600 is suited for use in isolated off-line systems requiring high-efficiency and advanced fault protection features including:

- Bias supplies for LCD monitors, LCD TV, PDP TV, and set top boxes
- AC/DC adapters
- Offline battery chargers
- Energy efficient power supplies up to 200 W

1.2 Features

The UCC28600EVM features include:

- 120-W, 19.4-V output
- Universal off-line input voltage range
- Power factor correction controlled by the UCC28051
- Multi-mode operation
- Current-mode control
 - Cycle-by-cycle power limit
- Programmable over voltage protection
- Internal over temperature protection
- Less than 500-mW input power during standby
- Programmable soft start
- PFC disable using the STATUS pin of the UCC28600
- Regulation down to zero output current
- Single-sided board layout

CAUTION

High voltage levels are present on the evaluation module whenever it is energized. Proper precautions must be taken when working with the EVM. The large bulk capacitor across the +DC IN and -DC IN terminals, and the output capacitor bank must be completely discharged before the EVM can be handled. Serious injury can occur if proper safety precautions are not followed.

2 UCC28600EVM Electrical Performance Specification
Table 1. UCC28600EVM Performance Summary

PARAMETERS	TEST CONDITION	MIN	TYP	MAX	UNITS
Input Characteristics					
Input voltage range	V_{IN}	85		265	V_{RMS}
Maximum input current	$V_{IN} = 115 V_{RMS}, I_{OUT} = 6.2 A$		1.3		A_{RMS}
	$V_{IN} = 230 V_{RMS}, I_{OUT} = 6.2 A$		0.7		
Input power factor correction	$V_{IN} = 115 V_{RMS}, I_{OUT} = 6.2 A$		0.998		
	$V_{IN} = 230 V_{RMS}, I_{OUT} = 6.2 A$		0.972		
Output Characteristics					
Output voltage	$85 V_{RMS} \leq V_{IN} \leq 265 V_{RMS}, 0 A \leq I_{OUT} \leq 6.2 A$	19.0	19.4	19.8	V
Output load current	$85 V_{RMS} \leq V_{IN} \leq 265 V_{RMS}$	0		6.2	A
Line regulation	$85 V_{RMS} \leq V_{IN} \leq 265 V_{RMS}, I_{OUT} = 3 A$		3		mV
Load regulation	$0 A \leq I_{OUT} \leq 6.2 A, V_{IN} = 115 V_{RMS}$		15		
		$0 A \leq I_{OUT} \leq 6.2 A, V_{IN} = 230 V_{RMS}$		15	
Output voltage ripple	$V_{IN} = 115 V_{RMS}, I_{OUT} = 6.2 A$		190		mV_{pk-pk}
	$V_{IN} = 230 V_{RMS}, I_{OUT} = 6.2 A$		190		
Output voltage noise	$V_{IN} = 115 V_{RMS}, I_{OUT} = 6.2 A$		190		
	$V_{IN} = 230 V_{RMS}, I_{OUT} = 6.2 A$		190		
Output over voltage limit	$V_{IN} = 115 V_{RMS}, I_{OUT} = 6.2 A$		23.4		V
	$V_{IN} = 230 V_{RMS}, I_{OUT} = 6.2 A$		23.6		
Control Loop Characteristics					
Control loop bandwidth	$V_{IN} = 115 V_{RMS}, I_{OUT} = 3 A$		2.6		kHz
Phase margin			70		degrees(°)
Efficiency					
Peak efficiency	$V_{IN} = 265 V_{RMS}, I_{OUT} = 6 A$		87.4%		
Full load efficiency	$V_{IN} = 115 V_{RMS}, I_{OUT} = 6.2 A$		82.7%		
	$V_{IN} = 230 V_{RMS}, I_{OUT} = 6.2 A$		86.4%		
No load power consumption	$V_{IN} = 115 V_{RMS}, I_{OUT} = 0 A$		230		mW
	$V_{IN} = 230 V_{RMS}, I_{OUT} = 0 A$		420		

3 Schematic

A schematic of the UCC28600EVM is shown in Figures 1 and 2. Terminal block J1 is the ac input voltage source connector, J2 is the 19.4-V output, and J3 is the output voltage return. The +DC IN and –DC IN connectors are used to monitor the PFC output voltage or can be used to supply a dc input voltage when the PFC stage is disabled.

Figure 1 shows the PFC controller, the UCC28051, with all the discrete circuitry for configuring the power factor correction at the universal line input range. The bias to the UCC28051 controller is provided by the auxiliary winding of the quasi-resonant flyback inductor and controlled by the STATUS output of the UCC28600 controller. During light load operation, the bias to the PFC controller is removed, enabling the converter to operate at high efficiencies.

Figure 2 shows the green-mode controller, the UCC28600, with all the discrete circuitry for configuring the isolated quasi-resonant flyback converter using the PFC output voltage as its input. The auxiliary winding provides the bias to the controllers and provides over voltage protection and valley switching information, as well as bias to the UCC28600 and UCC28051. The series resistor connected between the current sense pin and the current sense resistor programs the power limit of the converter. The series combination of R41 and D18 adds an offset voltage to the current sense signal that effectively reduces audible noise during standby operation by limiting the current in the transformer during operation in the audible frequency range.

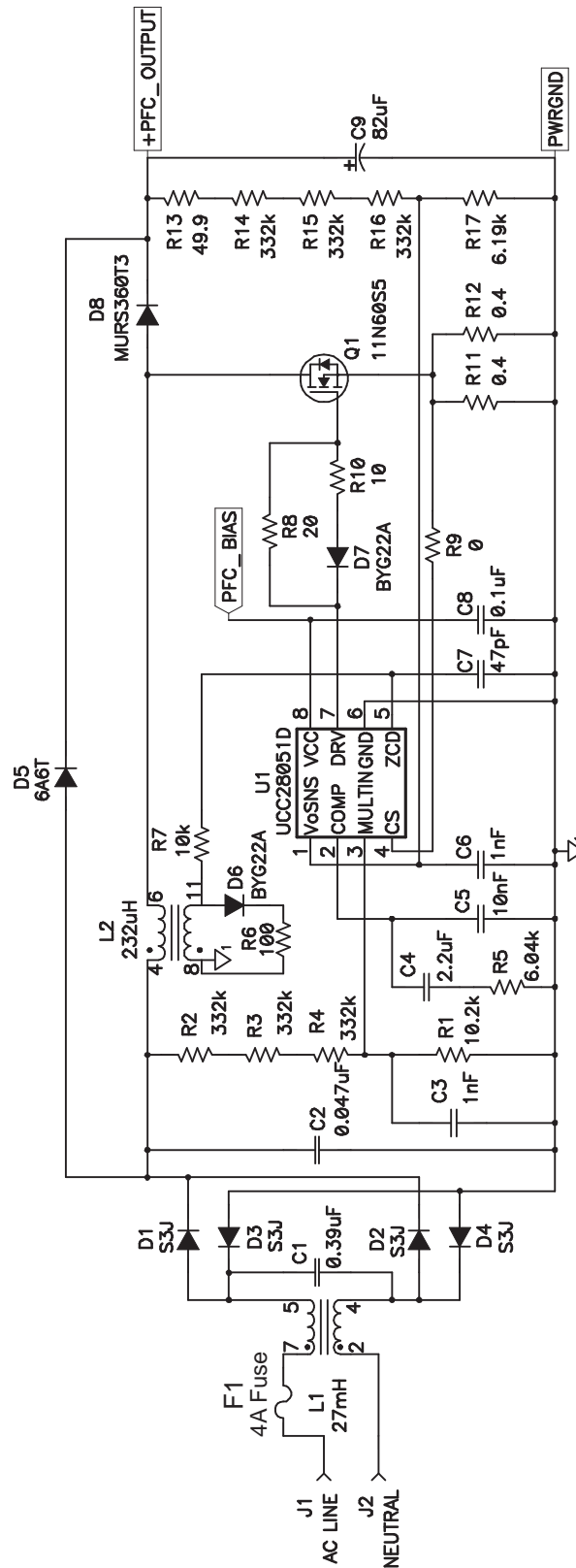

Figure 1. PFC Portion of the UCC28600EVM

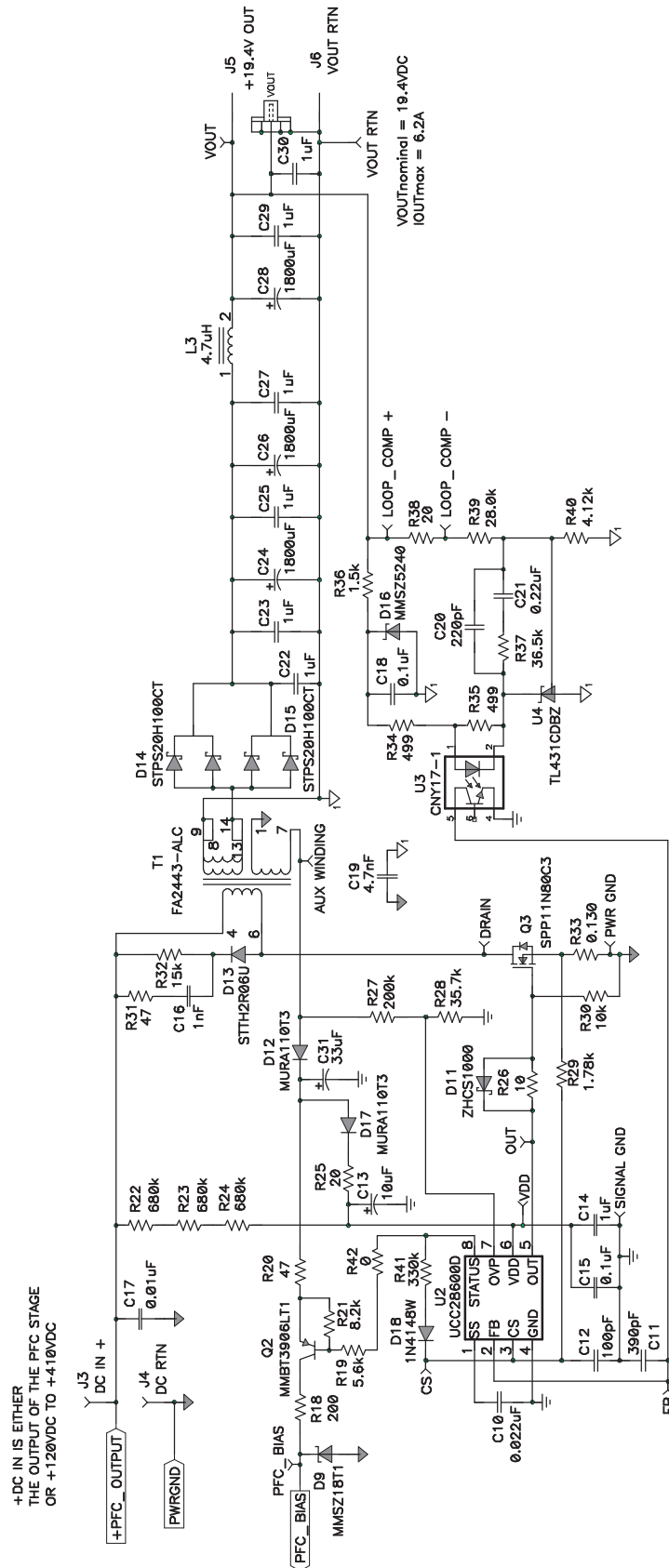

Figure 2. Quasi-Resonant Flyback Portion of the UCC28600EVM

4 EVM Test Setup

Figure 3 shows the basic test set up recommended to evaluate the UCC28600EVM with a load. Figure 4 shows the equipment set up when measuring the input power consumption when the EVM is in standby mode. Note the addition of the 10-Ω shunt in Figure 4. The power analyzer should also be set for long averaging in order to include several cycles of operation and an appropriate current scale factor for using the external shunt must be used.

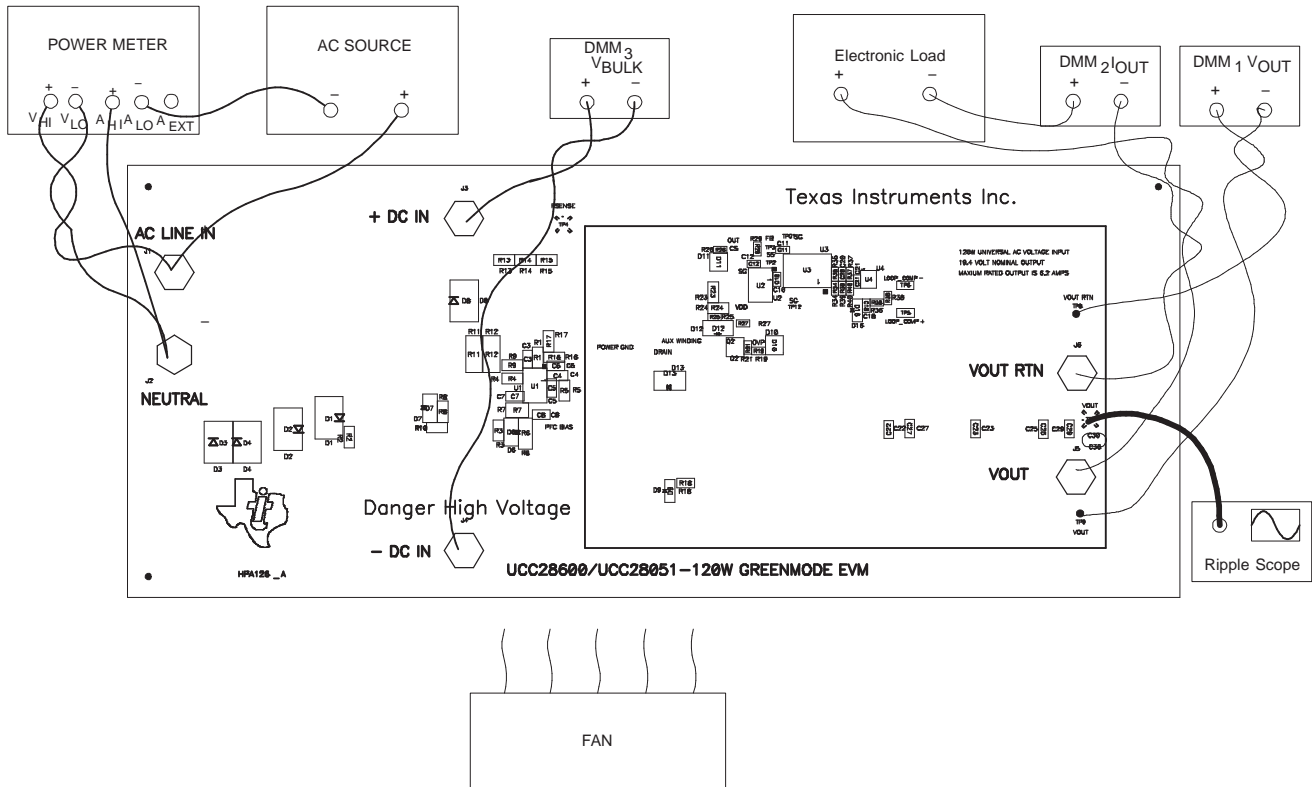

Figure 3. Recommended HPA126 EVM Test Configuration for Operation with a Load.

EVM Test Setup

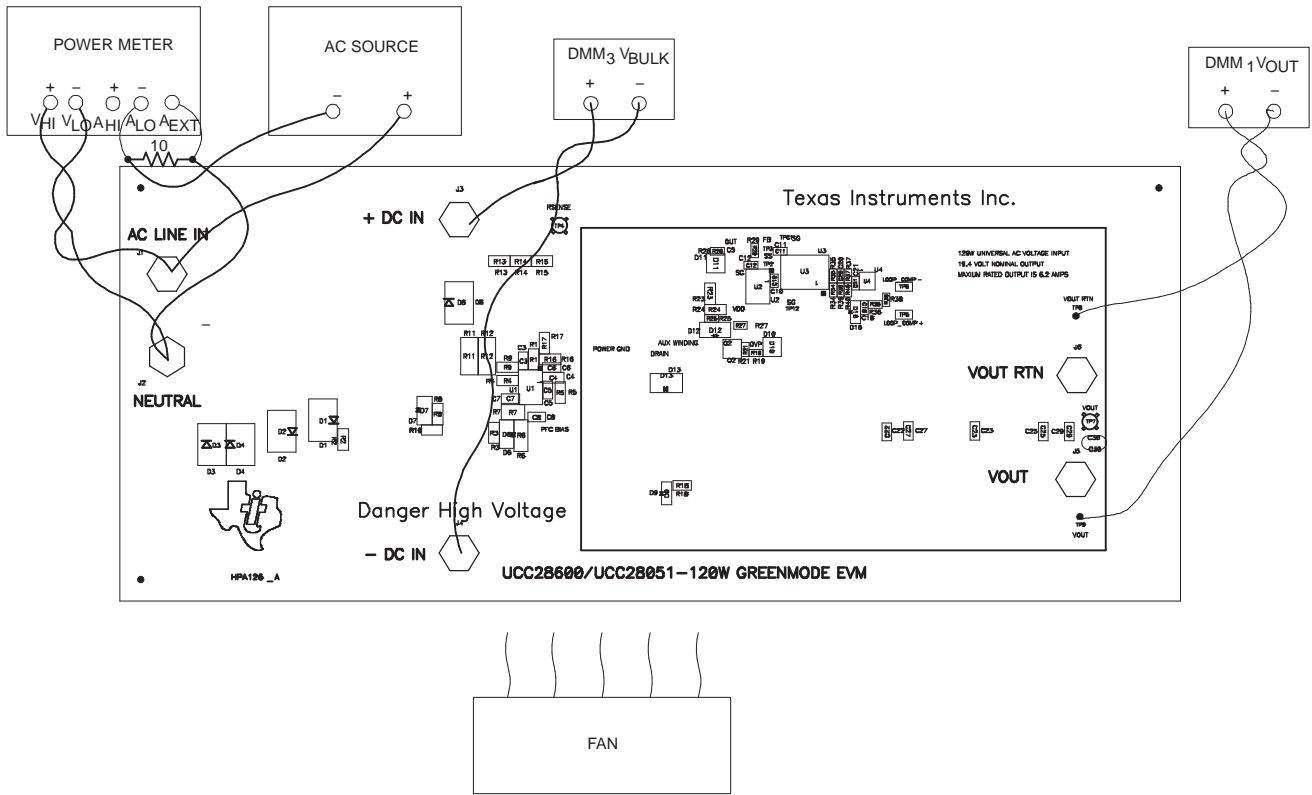

Figure 4. Equipment Set Up for HPA126 Evaluation During No-Load.

4.1 Power Meter

The power analyzer shall be capable of measuring low input current, typically less than 10 mA, and a long averaging mode if low power standby mode input power measurements are to be taken. An example of such an analyzer is the Voltech PM100 Single Phase Power Analyzer. To measure the intermittent bursts of current and power drawn from the line during no-load operation, an external 10- Ω shunt, with a current scale factor of 10 V/A, was used at a high sample rate over an extended period of time in order to display the averaged results (refer to Figure 4).

4.2 AC Input Source

The input source shall be a variable ac source capable of supplying between 85 V_{RMS} and 265 V_{RMS} at no less than 5-A peak and connected to the AC LINE IN terminal on the EVM, as shown in Figure 2. For accurate efficiency calculations, a power meter should be inserted between the neutral line of the ac source and the NEUTRAL terminal of the EVM. For highest accuracy, connect the voltage terminals of the power meter directly across the AC LINE IN and NEUTRAL terminals.

4.3 Digital Multimeters

Digital multimeters are used to measure the bulk dc voltage into the quasi-resonant converter stage (DMM₃), the output load current (DMM₂), and the regulated output voltage (DMM₁).

4.4 Output Load

For the output load, a programmable electronic load set to constant current mode and capable of sinking 0 to 7 A_{DC} at 20 V_{DC} shall be used. For highest accuracy, V_{OUT} can be monitored by connecting a dc voltmeter, DMM₁, directly across the VOUT and VOUT RTN test points as shown in Figure 2. A dc current meter, DMM₂, should be placed in series with the electronic load for accurate output current measurements.

4.5 Recommended Wire Gauge

The connection between the source voltage and the EVM input terminals can carry as much as 2 A peak. The minimum recommended wire size is AWG #20 with the total length of wire less than 8 feet (4 feet input, 4 feet return). The connection between the EVM output terminals and the load can carry as much as 6.2 A. The minimum recommended wire size is AWG #16, with the total length of wire less than 8 feet (4 feet output, 4 feet return).

4.6 Fan

Because this evaluation module is not enclosed, allowing probing of circuit nodes, a small fan capable of 200 LFM to 400 LFM should be used to reduce component temperatures when operating at or above 50% maximum rated load current.

5 Power-Up/Power-Down Procedure

The following test procedure is recommended primarily for power up and shutting down the evaluation module. The fan should be turned on whenever the EVM is running. Also, never leave a powered EVM unattended for any length of time.

1. Working at an ESD workstation, make sure that an ionizer is on before the EVM is removed from the protective packaging and power is applied to the EVM. Electrostatic smock and safety glasses should also be worn. Because voltages in excess of 400 V may be present on the EVM, do not connect the ground strap from the smock to the bench.
2. Power Up
 - a. Prior to connecting the ac input source, it is advisable to limit the source current to 5 A maximum. Make sure the ac source is initially set between 85 V_{RMS} and 265 V_{RMS} prior to turning on. Connect the ac source to the AC LINE IN and NEUTRAL terminals of the EVM as shown in Figure 3.
 - b. Connect the voltage terminals of the power analyzer across AC LINE IN and NEUTRAL as shown in Figures 3 and 4.
 - c. Connect the current meter terminals of the power analyzer in series with the NEUTRAL line as shown in Figure 3.
 - a. If no-load input power measurements are to be made, set the power analyzer to long averaging and external shunt mode. Insert a shunt, such as a 10-Ω resistor as shown in Figure 4, in series with the NEUTRAL terminal of the EVM. Set the appropriate current scale on the power analyzer.
 - d. Connect DMM₁ across VOUT and VOUT RTN as shown in Figures 3 and 4.
 - e. For operation with a load, connect the positive terminal of the LOAD to the VOUT terminal of the EVM and the negative terminal of the LOAD to the VOUT RTN terminal of the EVM, as shown in Figure 3. Connect DMM₂ in series with the negative terminal as shown in Figure 3. Set the LOAD to constant current mode to sink 0 A.
 - f. Connect DMM₃ across +DC IN and – DC IN as shown in Figures 3 and 4.
 - g. Make sure the output capacitor bank is completely discharged prior to power up.
 - h. Turn on the ac source and observe that the output is regulating to 19.4 V.
 - i. Increase load from 0 A up to 6.2 A.
3. Power Down
 - a. Turn off ac source.
 - b. Discharge the output capacitor bank.
 - c. Turn off the load.

6 UCC28600EVM Performance Data and Characteristic Curves

V_{OUT} Start-Up Overshoot. $V_{IN} = 115 V_{RMS}$, $I_{OUT} = 6.2 A$

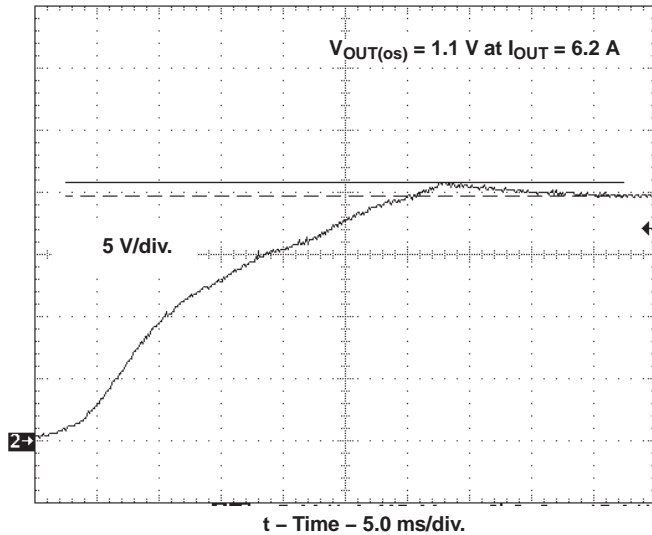

Figure 5.

Output Load Transient, 10% to 90% Load Step Change, $V_{IN} = 115 V_{RMS}$

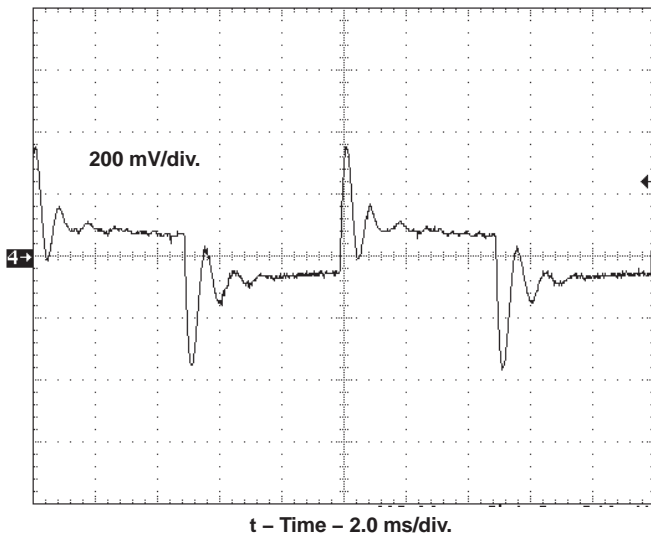

Figure 7.

V_{OUT} Start-Up Overshoot. $V_{IN} = 230 V_{RMS}$, $I_{OUT} = 6.2 A$

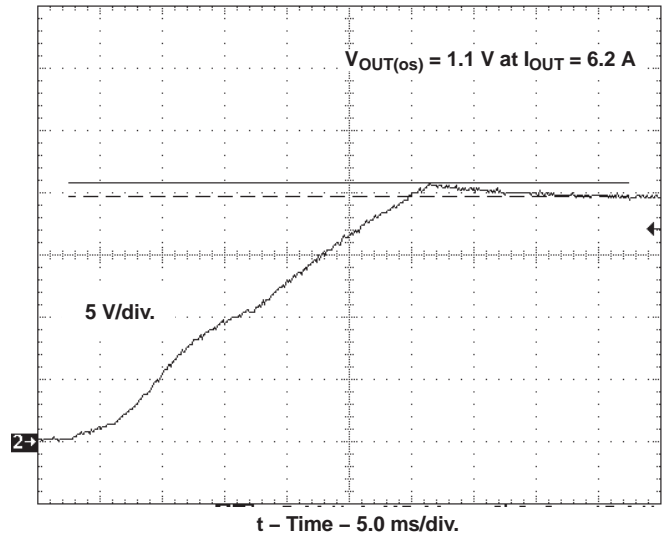

Figure 6.

Output Load Transient, 10% to 90% Load Step Change, $V_{IN} = 230 V_{RMS}$

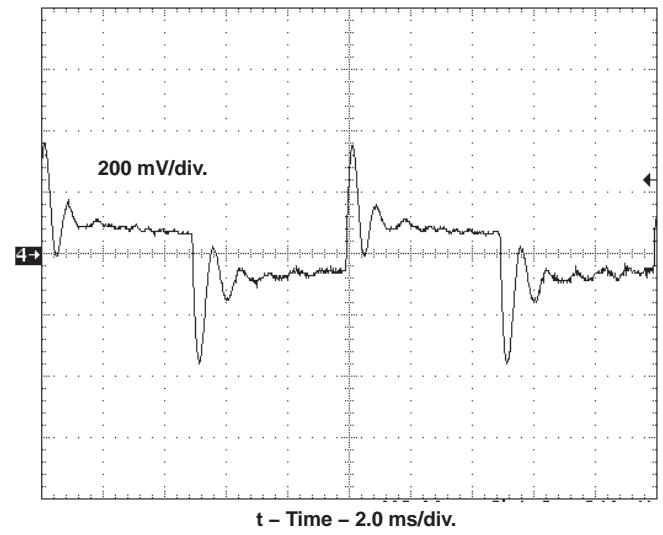
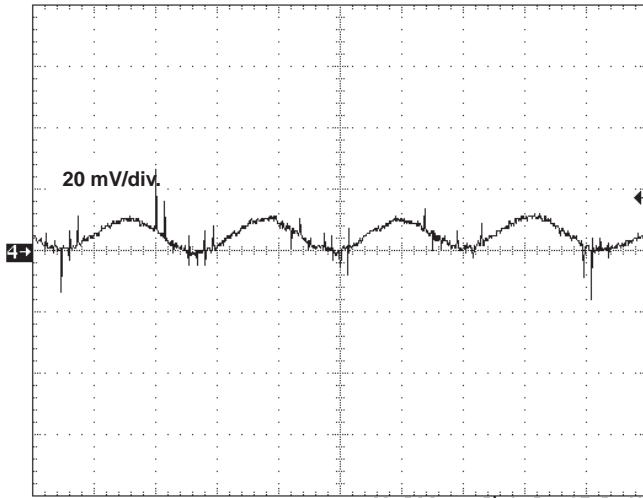

Figure 8.

Output Voltage Ripple and Noise, Green Mode, $V_{IN} = 230 V_{RMS}$, $I_{OUT} = 0.5 A$



t – Time – 200 μ s/div.

Figure 9.

Output Voltage Ripple and Noise, $V_{IN} = 115 V_{RMS}$, $I_{OUT} = 0.5 A$

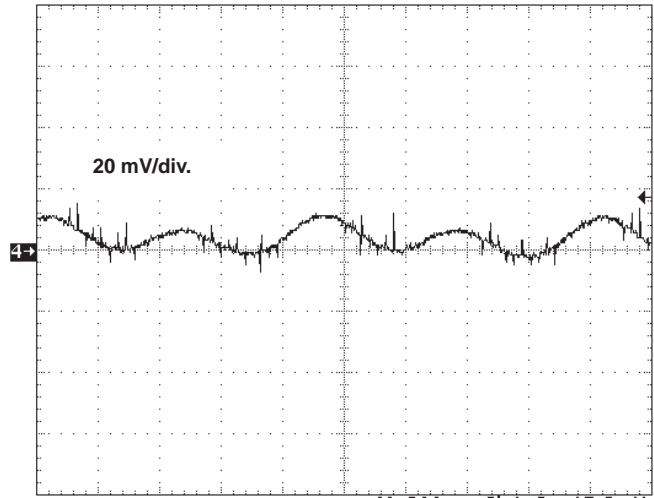

t – Time – 200 μ s/div.

Figure 10.

Output Voltage Ripple and Noise, $V_{IN} = 230 V_{RMS}$, $I_{OUT} = 6.2 A$

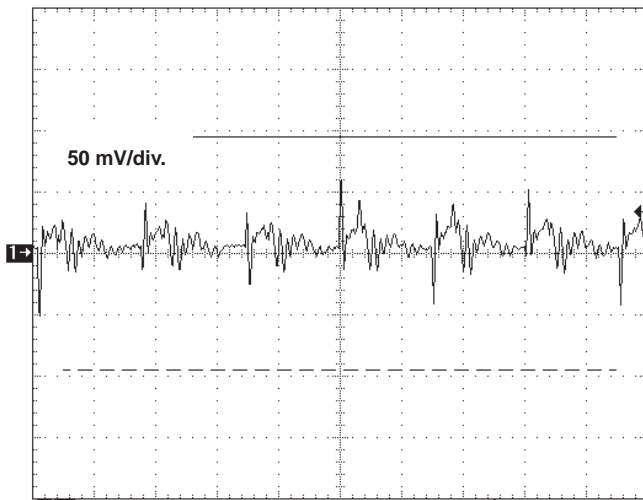

t – Time – 5.0 μ s/div.

Figure 11.

No Load Output Voltage Ripple, $V_{IN} = 230 V_{RMS}$

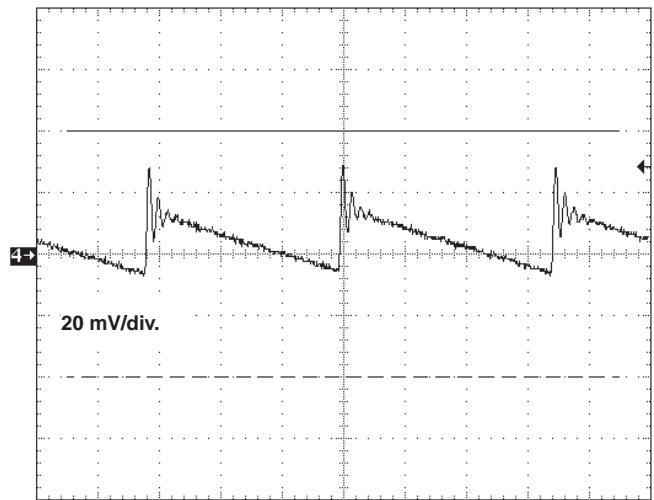

t – Time – 5.0 ms/div.

Figure 12.

No Load Output Voltage Ripple, $V_{IN} = 115 V_{RMS}$

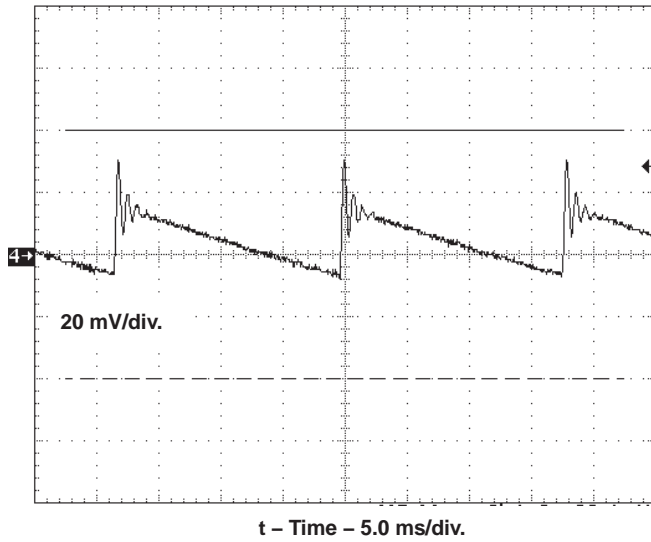

Figure 13.

Green Mode, Burst Pulses at 40 kHz, $V_{IN} = 115 V_{RMS}$, $I_{OUT} = 0.2 A$

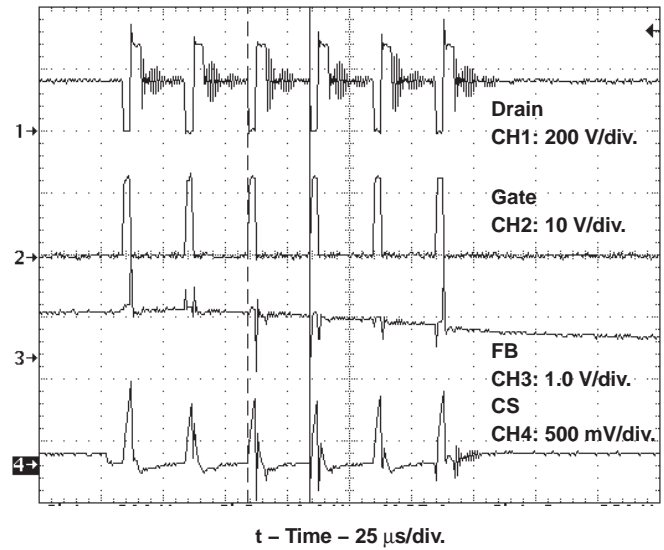

Figure 14.

Green Mode Showing Frequency of Burst Packets Equal to 900 Hz, $V_{IN} = 115 V_{RMS}$, $I_{OUT} = 0.2 A$

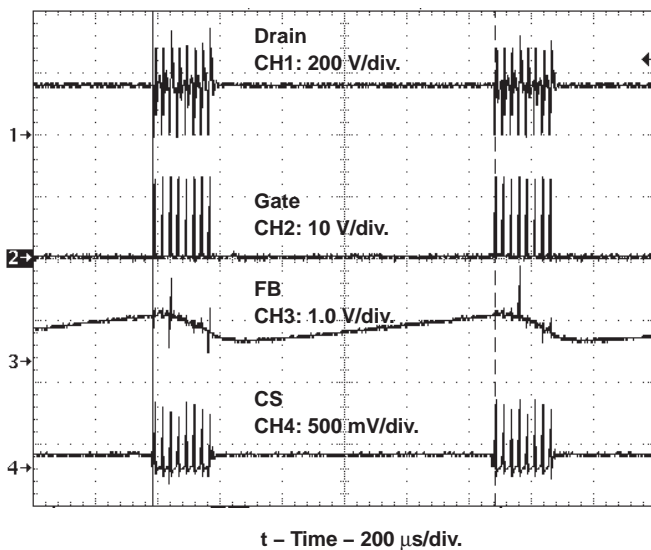

Figure 15.

Frequency Foldback Mode, Switching Frequency = 115 kHz, $V_{IN} = 115 V_{RMS}$, $I_{OUT} = 1.6 A$

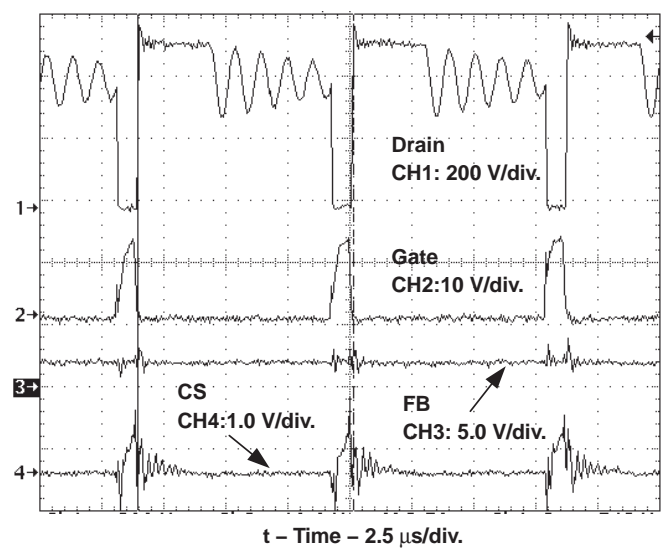

Figure 16.

Discontinuous Current Mode, Switching Frequency = 130 kHz, $V_{IN} = 115 V_{RMS}$, $I_{OUT} = 4.6 A$

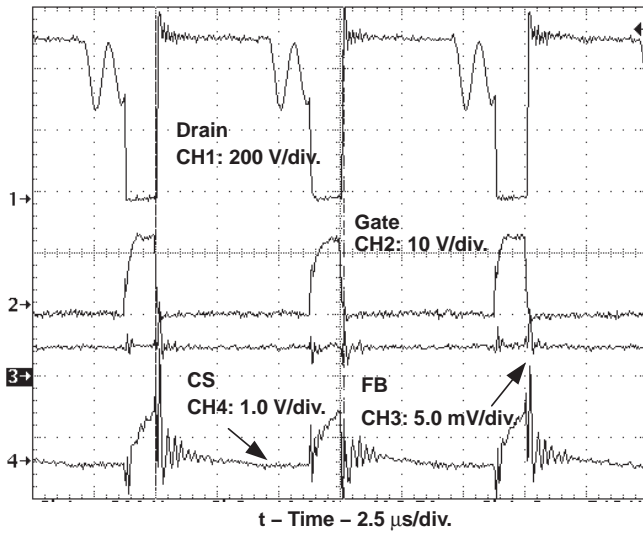

Figure 17.

OUTPUT VOLTAGE
vs.
OUTPUT CURRENT

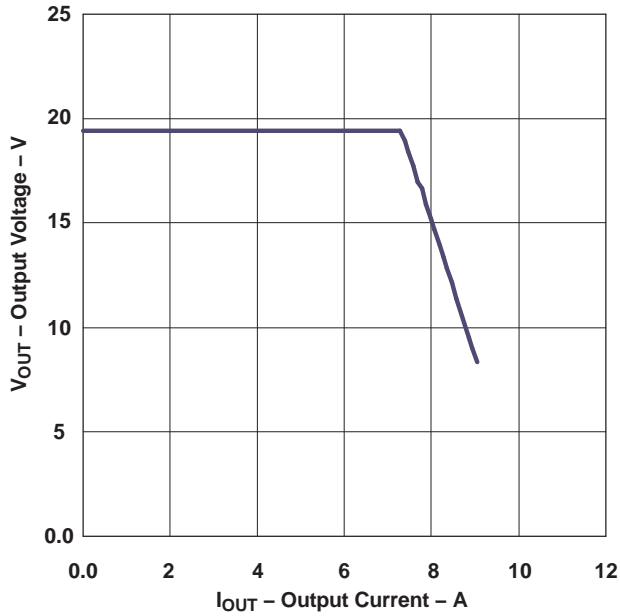

Figure 19.

Quasi-Resonant Mode, Switching Frequency = 116 kHz, $V_{IN} = 115 V_{RMS}$, $I_{OUT} = 5.6 A$

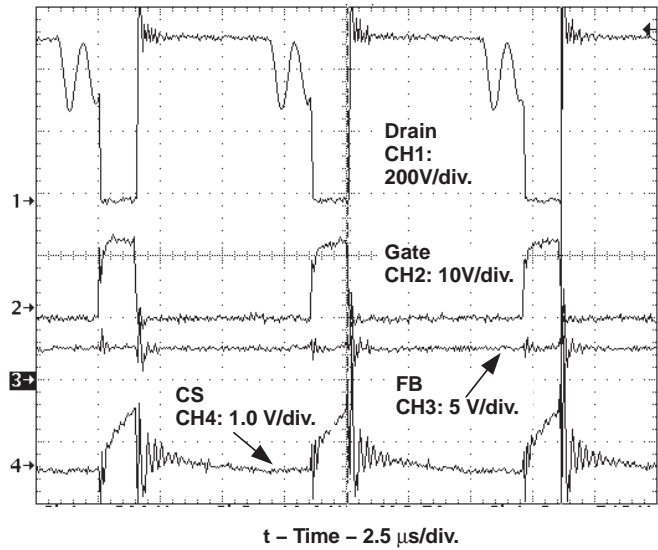

Figure 18.

PHASE/GAIN
vs.
FREQUENCY

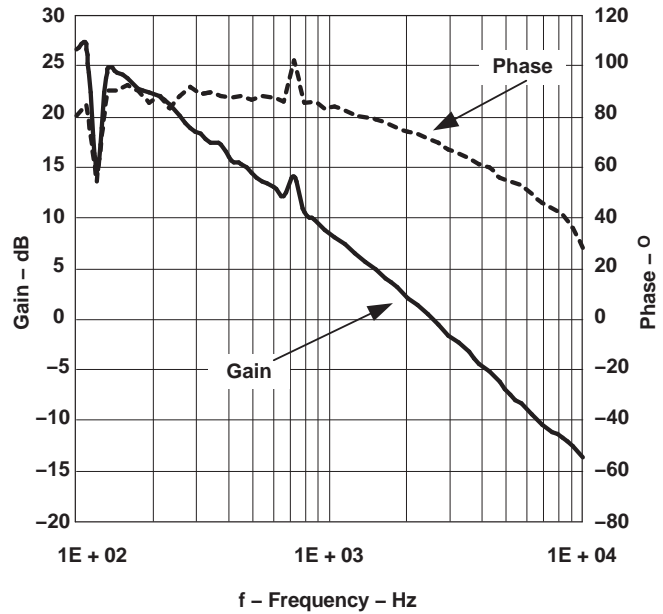

Figure 20.

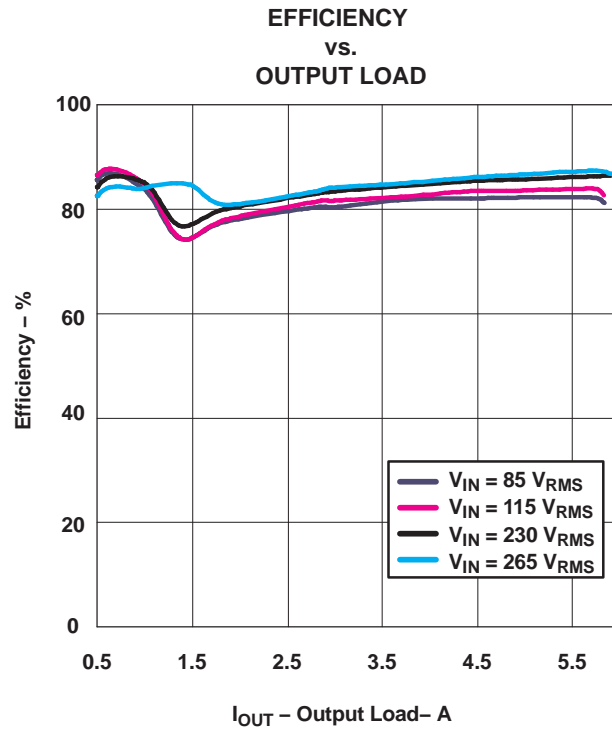

Figure 21.

7 EVM Assembly Drawing and Layout

Figures 22 and 23 show the layout of the single-sided printed circuit board used for the evaluation module.

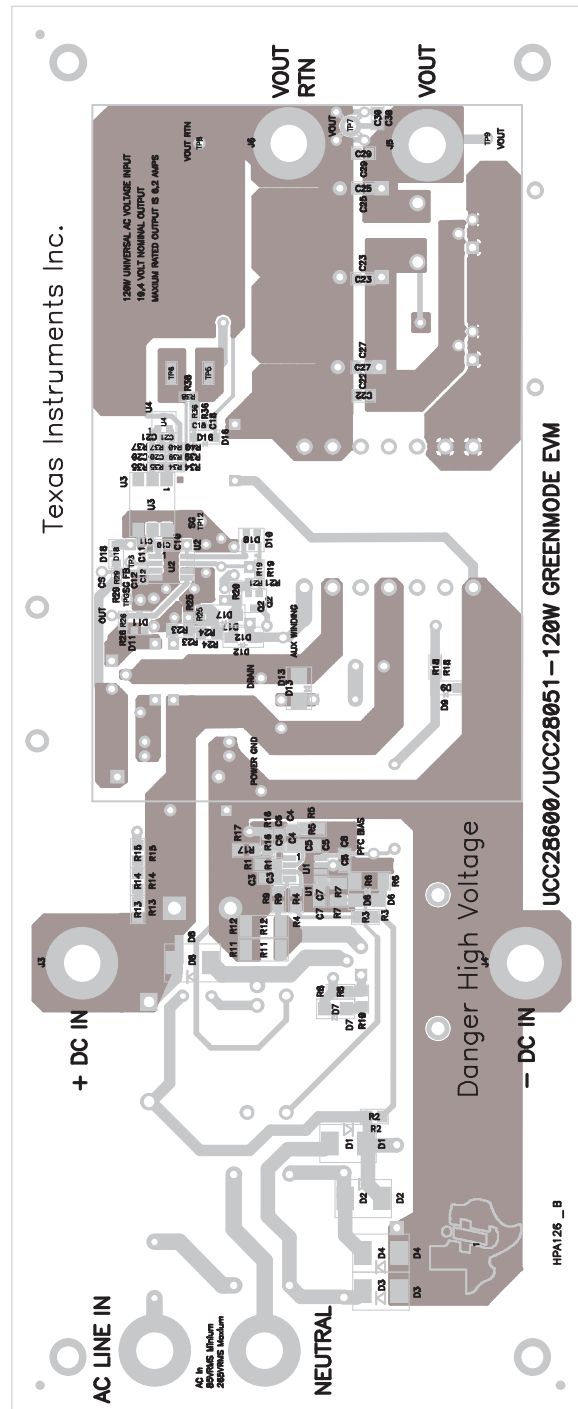

Figure 22. Top Layer of EVM

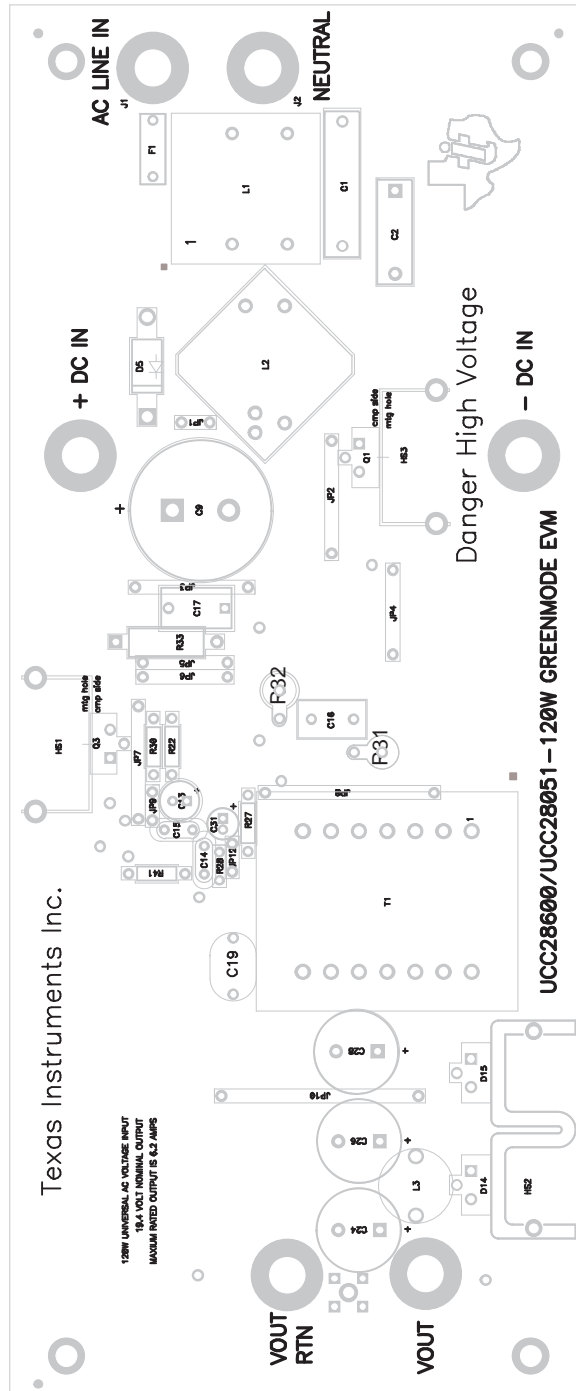

Figure 23. Bottom Layer of EVM

8 List of Materials

Table 2. Material List for EVM⁽¹⁾⁽²⁾

REF DESIGNATOR	QTY	DESCRIPTION	MANUFACTURE	PART NUMBER
C1	1	Capacitor, metal poly, 0.39 μ F, 630 V, -40/+85 °C, \pm 10%, 0.236 x 1.043	ST Microelectronics	ECQ-E6394KF
C2	1	Capacitor, metal poly, 0.047 μ F, 630 V, -40/+85 °C, \pm 10%, 0.709 x 0.236	ST Microelectronics	ECQ-E6473KF
C3, C6	2	Capacitor, ceramic, 1 nF, 50 V, X7R, \pm 10%, 0805	ON Semiconductor	C0805C102K5RACTU
C4	1	Capacitor, ceramic, 2.2 μ F, 16 V, X7R, \pm 10%, 1206	Diodes Inc	ECJ-3YB1C225K
C5	1	Capacitor, ceramic, 10 nF, 50 V, X7R, \pm 10%, 0805	Littelfuse	C0805C103K5RACTU
C7	1	Capacitor, ceramic, 47 pF, 50 V, C0G, \pm 5%, 0805	Cooper Electronic Technologies	C0805C470J5GACTU
C8	1	Capacitor, ceramic, 0.1 μ F, 25 V, X7R, \pm 10%, 0805	Cooper Electronic Technologies	ECJ-2VB1E104K
C9	1	Capacitor, aluminum electrolytic, 82 μ F, 450 V _{DC} , -40/+85 °C, \pm 20%, 0.984 inch Dia.	Coilcraft	EET-ED2W820CA
C10	1	Capacitor, ceramic, 0.022 μ F, 25 V, X7R, \pm 10%, 0603	Infineon Technologies	ECJ-1VB1E223K
C11	1	Capacitor, ceramic, 390 pF, 50 V, X7R, \pm 10%, 0603	Infineon Technologies	GRM188R71H391KA01D
C12	1	Capacitor, ceramic, 100 pF, 100 V, C0G, \pm 5%, 0603	infineon Technologies	GRM1885C2A101JA01D
C13	1	Capacitor, electrolytic, 10 μ F, 100 V, -40/+105 °C, \pm 20%, 0.200 inch	Yageo America	EEU-FC2A100
C14	1	Capacitor, ceramic, 1 μ F, 50 V, X7R, \pm 10%, 0.200 x 0.256 inch	Yageo America	B37984M5105K000
C15	1	Capacitor, ceramic, 0.1 μ F, 50 V, X7R, \pm 10%, 0.200 x 0.256 inch	Yageo America	B37987F5104K054
C16	1	Capacitor, ceramic disc, 1 nF, 1 kV, X5R, \pm 10%, 0.265 x 0.472 inch	Panasonic - ECG	562R-10TSD10
C17	1	Capacitor, polyester Film, 0.01 μ F, 630 V, -40/+85 °C, \pm 10%, 0.472 x 0.177 inch	Panasonic - ECG	ECQ-E6103KF
C18	1	Capacitor, ceramic, 0.1 μ F, 16 V, X7R, \pm 10%, 0603	Kemet	C0603C104M4RACTU
C19	1	Capacitor, ceramic disc, 4.7 nF, 250 V, -25/+85 °C, \pm 20%, 0.394 x 0.315 inch	Panasonic - ECG	ECK-ANA472ME
C20	1	Capacitor, ceramic, 220pF, 100 V, C0G, \pm 5%, 0603	Murata Electronics	GRM1885C2A221JA01D
C21	1	Capacitor, ceramic, 0.22 μ F, 25 V, X7R, \pm 10%, 0603	AVX CORPORATION	06033D224KAT2A
C22, C23, C25, C27, C29, C30	6	Capacitor, ceramic, 1 μ F, 25 V, X5R, \pm 10%, 0805	Panasonic - ECG	ECJ-2FB1E105K
C24, C26, C28	3	Capacitor, aluminum electrolytic, 1800 μ F, 25 V, \pm 20%, 0.571 inch	United Chemi-Con	EKZE250ELL182MK30S
C31	1	Capacitor, electrolytic, 33 μ F, 50 V, \pm 20%, 0.200 inch	Panasonic - ECG	EEU-FC1H330
D1, D2, D3, D4	4	Diode, rectifier GPP, 3 A, 600 V, SMC	Diodes Inc	S3J-13-F
D5	1	Diode, rectifier, 6 A, 400 A peak surge, 600 V, P600	Diodes Inc	6A6-T
D6, D7	2	Diode, fast recovery, 2 A, 600 V, SMA	ST Microelectronics	STTH2R06A
D8	1	Diode, ultra fast, 3 A, 600 V, SMC	ON Semiconductor	MURS360T3
D9	1	Diode, zener, 500 mW, 18 V, SOD-123	ON Semiconductor	MMSZ18T1
D11	1	Diode, schottky, 1 A, 40 V, SOT-23	Central Semiconductor	ZHCS1000
D12, D17	2	Diode, ultra fast rectifier, 1 A, 100 V, SMA	ON Semiconductor	MURA110T3

(1) These assemblies are ESD sensitive, ESD precautions shall be observed.

(2) These assemblies must comply with workmanship standards IPC-A-610 Class 2.

Table 2. Material List for EVM (continued)

REF DESIGNATOR	QTY	DESCRIPTION	MANUFACTURE	PART NUMBER
D13	1	Diode, fast rectifier, 2 A, 600 V, SMB	STMicroelectronics	STTH2R06U
D14, D15	2	Diode, dual schottky, 2x10 A, 100 V, TO-220AB	STMicroelectronics	STPS20H100CT
D16	1	Diode, zener, 500 mW, 10 V, SOD-123	ON Semiconductor	MMSZ5240BT1
D18	1	Diode, signal, 300 mA, 75 V, 350 mW, SOD-123	Diodes Inc	1N4148W-7
F1	1	Fuse, axial, fast acting, 4 A, 250 V, 0.145 x 0.300 inch	Littelfuse	0263004.M
L1	1	Inductor, dual winding, 27 mH, 1.032 x 1.043 inch	Cooper Electronic Technologies	CTX16-16926
L2	1	Xfmr, boost inductor, 232 μ H, 1.122 x 1.122 inch	Cooper Electronic Technologies	CTX16-17298
L3	1	Inductor, power choke, 4.7 μ H, 0.500 inch	Coilcraft	PCV-0-472-10L
Q1	1	MOSFET, N-channel, 650 V, 11 A, 380 m Ω , TO-220V	Infineon Technologies	11N60S5
Q2	1	Bipolar, PNP, 40V, 200mA, SOT-23	Infineon Technologies	MMBT3906LT1
Q3	1	MOSFET, cool MOS power N-channel, 800 V, 11 A, 450 m Ω , TO-220AB	Infineon Technologies	SPP11N80C3
R1	1	Resistor, chip, 10.2 k Ω , 1/4 W, \pm 1%, 1206	Yageo America	RC1206FR-0710K2L
R2, R3, R4, R14, R15, R16	6	Resistor, chip, 332 k Ω , 1/4 W, \pm 1%, 1206	Yageo America	9C12063A3323FKHFT
R5	1	Resistor, chip, 6.04 k Ω , 1/4 W, \pm 1%, 1206	Yageo America	9C12063A6041FKHFT
R6	1	Resistor, chip, 100 Ω , 1/2 W, \pm 1%, 2010	Panasonic - ECG	ERJ-12SF1000U
R7	1	Resistor, chip, 10 k Ω , 1/4 W, \pm 1%, 1210	Panasonic - ECG	ERJ-14NF1002U
R8	1	Resistor, chip, 20 Ω , 1/4 W, \pm 1%, 1206	Yageo America	RC1206FR-0720RL
R9	1	Resistor, chip, 0 Ω , 1/4 W, \pm 5%, 1206	Yageo America	9C12063A0R00JLHFT
R10	1	Resistor, chip, 10 Ω , 1/4 W, \pm 1%, 1206	Yageo America	9C12063A10R0FKHFT
R11, R12	2	Resistor, chip, 0.4 Ω , 1 W, \pm 1%, 2512	Vishay/Dale	WSL2512R4000FEA
R13	1	Resistor, chip, 49.9 Ω , 1/4 W, \pm 1%, 1206	Yageo America	RC1206FR-0749R9L
R17	1	Resistor, chip, 6.19 k Ω , 1/4 W, \pm 1%, 1206	Yageo America	RC1206FR-076K19L
R18	1	Resistor, chip, 200 Ω , 1/8 W, \pm 1%, 0805	Rohm	MCR10EZHF2000
R19	1	Resistor, chip, 5.6 k Ω , 1/10 W, \pm 5%, 0603	Rohm	MCR03EZPJ562
R20	1	Resistor, chip, 47 Ω , 1/8 W, \pm 1%, 0805	Rohm	MCR10EZHF47R0
R21	1	Resistor, chip, 8.2 k Ω , 1/10 W, \pm 5%, 0603	Yageo America	RC0603JR-078K2L
R22	1	Resistor, metal film, 680 k Ω , 1/4 W, \pm 1%, axial, RN55	Panasonic - ECG	ERO-S2PHF6803
R23, R24	2	Resistor, chip, 680 k Ω , 1/4 W, \pm 5%, 1206	Rohm	ERJ-8GEYJ684V
R25	1	Resistor, chip, 20 Ω , 1/10 W, \pm 5%, 0603	Panasonic - ECG	ERJ-3GEYJ200V
R26	1	Resistor, chip, 10 Ω , 1/16 W, \pm 1%, 0603	Panasonic - ECG	ERJ-3KEF10R0V
R27	1	Resistor, metal film, 200 k Ω , 1/4 W, \pm 1%, axial, RN55	Yageo America	MFR-25FRF-200K
R28	1	Resistor, metal film, 35.7 k Ω , 1/4 W, \pm 1%, 0.300 X 0.100 inch	Yageo America	MFR-25FBF-35K7
R29	1	Resistor, chip, 1.78 k Ω , 1/10 W, \pm 1%, 0603	Rohm	MCR03EZPFX2051
R30	1	Resistor, metal film, 10 k Ω , 1/4 W, \pm 1%, axial, RN55	Panasonic - ECG	ERO-S2PHF1002
R31	1	Resistor, metal oxide, 47 Ω , 3 W, \pm 5%, 1.300 X 0.205 inch	RCD Components Inc.	RMF3-470-J
R32	1	Resistor, metal oxide, 15 k Ω , 3 W, \pm 5%, 1.300 X 0.205 inch	Panasonic - ECG	P15KW-3BK-ND
R33	1	Resistor, wirewound, 0.13 Ω , 3 W, \pm 1%, axial, 0.600 X 0.250 inch	Huntington Electric	ALSR-3-.13-1%
R34, R35	2	Resistor, chip, 499 Ω , 1/10 W, \pm 1%, 0603	Yageo America	RC0603FR-07499RL

Table 2. Material List for EVM (continued)

REF DESIGNATOR	QTY	DESCRIPTION	MANUFACTURE	PART NUMBER
R36	1	Resistor, chip, 1.5 k Ω , 1/10 W, \pm 1%, 0603	Yageo America	RC0603FR-071K5L
R37	1	Resistor, chip, 36.5 k Ω , 1/10 W, \pm 1%, 0603	Yageo America	RC0603FR-0736K5L
R38	1	Resistor, chip, 20 Ω , 1/10 W, \pm 5%, 0603	Yageo America	RC0603JR-0720RL
R39	1	Resistor, chip, 28 k Ω , 1/10 W, \pm 1%, 0603	Yageo America	RC0603FR-0728KL
R40	1	Resistor, chip, 4.12 k Ω , 1/10 W, \pm 1%, 0603	Yageo America	RC0603FR-074K12L
R41	1	Resistor, metal film, 330 k Ω , 1/2 W, \pm 5%, axial	Phoenix Passive Components	2306 242 23334
R42	1	Resistor, chip, 0.0 Ω , 1/10 W, \pm 5%, 0603	Panasonic - ECG	ERJ-3GEY0R00V
T1	1	Transformer	Coilcraft	FA2443-ALC
U1	1	IC, Transistion Mode PFC Controller, SO8	Texas Instrumants	UCC28051D**
U2	1	IC, Quasi-Resonant Flyback Green-Mode Controller, SO8	Texas Instrumants	UCC28600D**
U3	1	IC, Optocoupler, NPN w/base, DIP6	Vishay	CNY17-1
U4	1	IC, Precision Adjustable Shunt Regulator, SOT23-3	Texas Instrumants	TL1431QDBZ**

9 References

1. UCC28600 8-Pin Quasi-Resonant Flyback Green Mode Controller, Datasheet, SLUS646B
2. Standby and Low Power Measurements, VOLTECHNOTES, VPN 104-054/1, <http://www.voltech.com/Downloads/PMAppNotes/Low%20Power%20Standby.pdf>

IMPORTANT NOTICE

Texas Instruments Incorporated and its subsidiaries (TI) reserve the right to make corrections, modifications, enhancements, improvements, and other changes to its products and services at any time and to discontinue any product or service without notice. Customers should obtain the latest relevant information before placing orders and should verify that such information is current and complete. All products are sold subject to TI's terms and conditions of sale supplied at the time of order acknowledgment.

TI warrants performance of its hardware products to the specifications applicable at the time of sale in accordance with TI's standard warranty. Testing and other quality control techniques are used to the extent TI deems necessary to support this warranty. Except where mandated by government requirements, testing of all parameters of each product is not necessarily performed.

TI assumes no liability for applications assistance or customer product design. Customers are responsible for their products and applications using TI components. To minimize the risks associated with customer products and applications, customers should provide adequate design and operating safeguards.

TI does not warrant or represent that any license, either express or implied, is granted under any TI patent right, copyright, mask work right, or other TI intellectual property right relating to any combination, machine, or process in which TI products or services are used. Information published by TI regarding third-party products or services does not constitute a license from TI to use such products or services or a warranty or endorsement thereof. Use of such information may require a license from a third party under the patents or other intellectual property of the third party, or a license from TI under the patents or other intellectual property of TI.

Reproduction of information in TI data books or data sheets is permissible only if reproduction is without alteration and is accompanied by all associated warranties, conditions, limitations, and notices. Reproduction of this information with alteration is an unfair and deceptive business practice. TI is not responsible or liable for such altered documentation.

Resale of TI products or services with statements different from or beyond the parameters stated by TI for that product or service voids all express and any implied warranties for the associated TI product or service and is an unfair and deceptive business practice. TI is not responsible or liable for any such statements.

Following are URLs where you can obtain information on other Texas Instruments products and application solutions:

Products		Applications	
Amplifiers	amplifier.ti.com	Audio	www.ti.com/audio
Data Converters	dataconverter.ti.com	Automotive	www.ti.com/automotive
DSP	dsp.ti.com	Broadband	www.ti.com/broadband
Interface	interface.ti.com	Digital Control	www.ti.com/digitalcontrol
Logic	logic.ti.com	Military	www.ti.com/military
Power Mgmt	power.ti.com	Optical Networking	www.ti.com/opticalnetwork
Microcontrollers	microcontroller.ti.com	Security	www.ti.com/security
Low Power Wireless	www.ti.com/lpw	Telephony	www.ti.com/telephony
		Video & Imaging	www.ti.com/video
		Wireless	www.ti.com/wireless

Mailing Address: Texas Instruments
Post Office Box 655303 Dallas, Texas 75265